

Greiferkomponenten

Profitieren sie von unserem umfangreichen Sortiment an Sauger und Zangen.

Flachsauger
Faltenbalgsauger
Ovalsauger

Anschlusselemente
Federelemente
Baugruppen
Zusatzelemente

Zangen



Flachsauger

Flachsauger SI Ø 3.5 mm - Art.-Nr. C003089

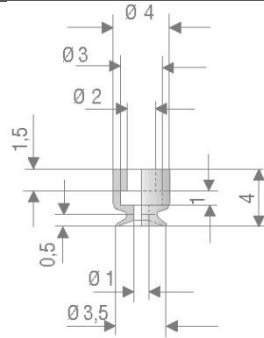
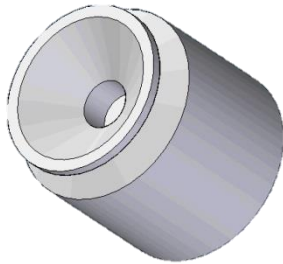

Flachsauger aus Silikon
Temperaturbeständig bis 200°C

Federelement:
- C003091

Flachsauger SI Ø 4mm - Art.-Nr. H004801

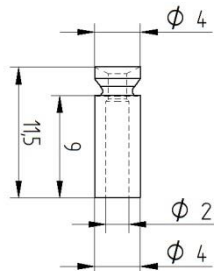
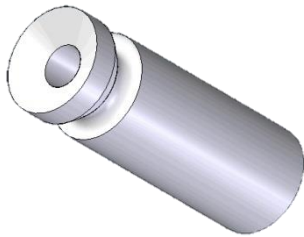

Flachsauger aus Silikon
Temperaturbeständig bis 200°C

Anschlusselement:
- H004831

Federelement:
- H004981

Flachsauger SI Ø6 - Art.-Nr. C003090

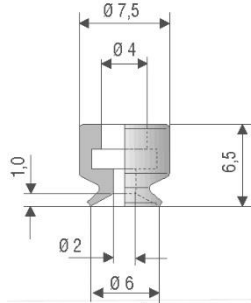
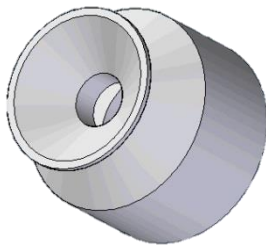

Flachsauger aus Silikon
Temperaturbeständigkeit bis 200°C

Federelement:
- C003092

Flachsauger NBR Ø 6 mm - Art.-Nr. H004812

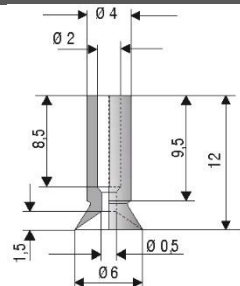
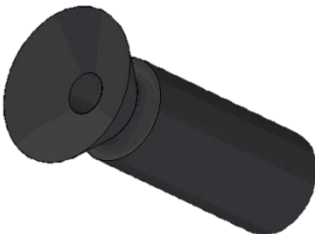

Flachsauger aus NBR
Temperaturbeständig bis 90°C

Anschlusselement:
- H004831

Federelement:
- H004981



Flachsauger SI Ø 6 mm - Art.-Nr. H004802

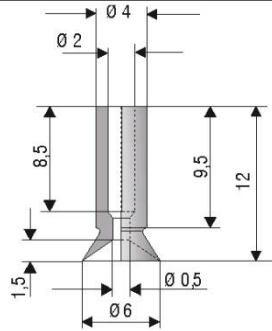
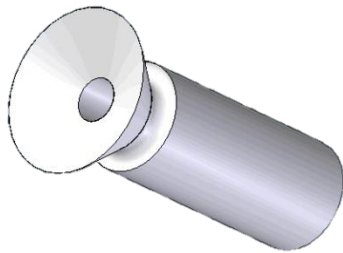

Flachsauger aus Silikon
Temperaturbeständig bis 200°C

Anschlusselement:
- H004831

Federelement:
- H004981

Flachsauger SI Ø 10 mm - Art.-Nr. H004803

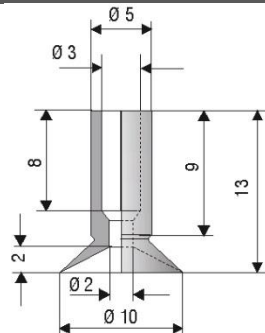
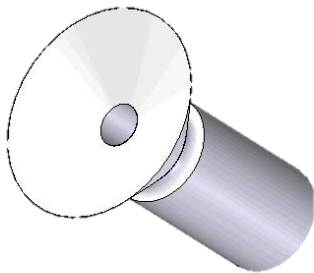

Flachsauger aus Silikon
Temperaturbeständig bis 200°C

Anschlusselement:
- H004833

Federelement:
- H004982

Flachsauger SI Ø 15 mm - Art.-Nr. C003071

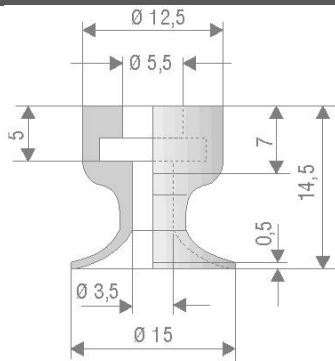
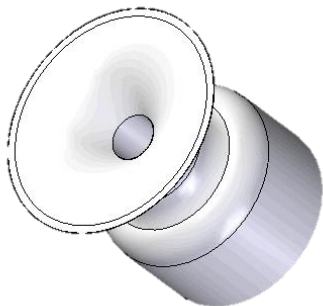

Flachsauger aus Silikon
Temperaturbeständigkeit bis 200°C

Anschlusselement:
- C003070

Flachsauger SI Ø 16 mm - Art.-Nr. H004804

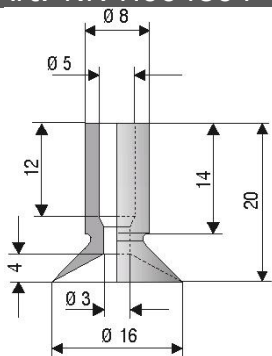
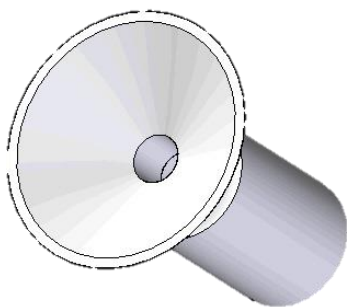

Flachsauger aus Silikon
Temperaturbeständig bis 200°C

Anschlusselement:
- H004832



Flachsauger SI Ø 25 mm - Art.-Nr. H004805

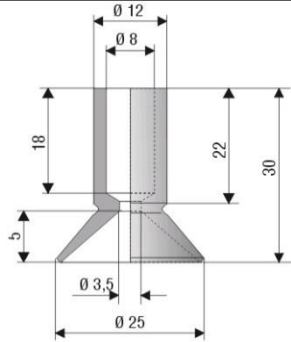
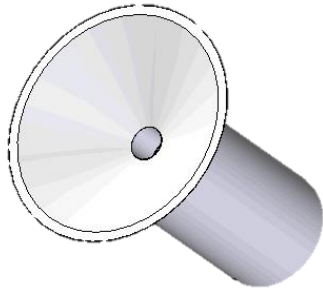

Flachsauger aus Silikon
Temperaturbeständig bis 200°C

Anschlusselement:
- H004833

Flachsauger SI Ø 30 mm - Art.-Nr. C003081

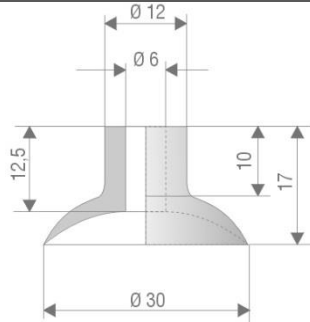
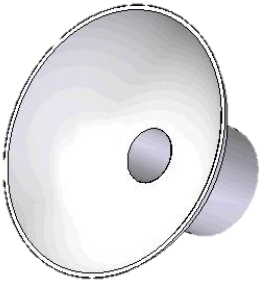

Flachsauger aus Silikon
Temperaturbeständig bis 200°C

Anschlusselement:
- C003082

Flachsauger SI Ø 40 mm - Art.-Nr. H004806

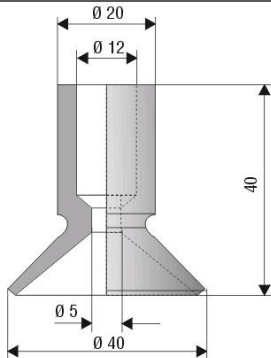
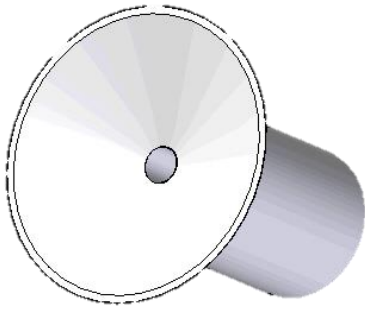

Flachsauger aus Silikon
Temperaturbeständig bis 200°C

Anschlusselement:
- H004834

Flachsauger SI Ø 80 mm - Art.-Nr. H004865



Flachsauger aus Silikon
Temperaturbeständig bis 200°C

Anschlusselement:
- H004869



Faltenbalgsauger

Faltenbalgsauger SI Ø 6 mm - Art.-Nr. H004901

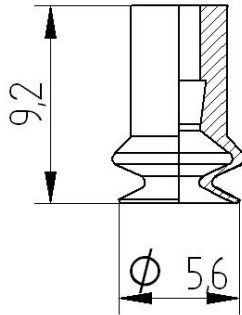

Faltenbalgsauger aus Silikon
Temperaturbeständigkeit bis 200°C

Balghub: 1.5 mm

Anschlusselement:
- H004931

Faltenbalgsauger SI Ø 6.5 mm - Art.-Nr. C003021

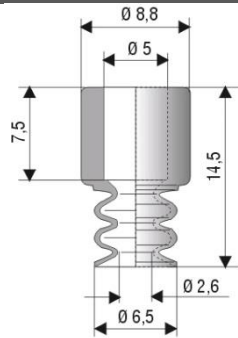

Faltenbalgsauger aus Silikon
Temperaturbeständigkeit bis 200°C

Balghub: 3.5 mm

Anschlusselement:
- C003058
- C003070

Faltenbalgsauger Vinyl Ø 6.5 mm - Art.Nr. C003029

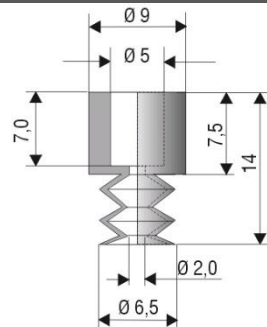
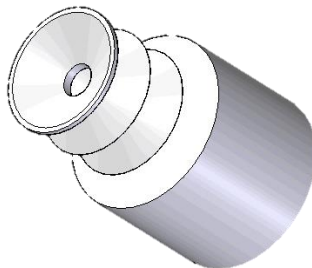

Faltenbalgsauger aus Vinyl
Temperaturbeständigkeit bis 85°C

Balghub: 3.5 mm

Anschlusselement:
- C003058
- C003070

Faltenbalgsauger SI Ø 10 mm - Art.-Nr. C003022

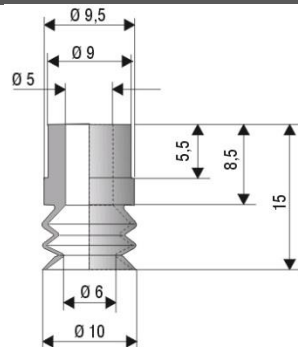
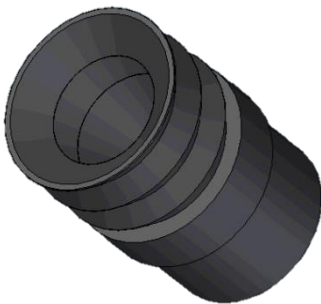

Faltenbalgsauger aus Silikon
Temperaturbeständig bis 200°C

Balghub: 4 mm

Anschlusselement:
- C003082



Faltenbalgsauger NBR Ø 10 mm - Art.Nr. H004905

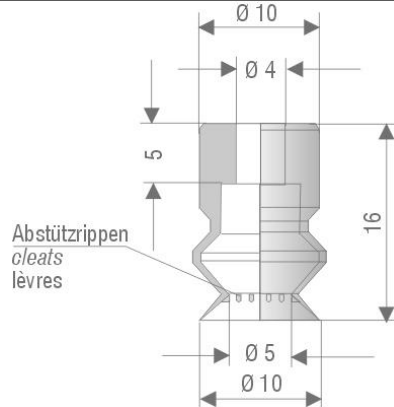

Faltenbalgsauger aus NBR
Temperaturbeständig bis 90°C

Balghub: 4.5 mm

Faltenbalgsauger SI Ø 10 mm - Art.Nr. C004902

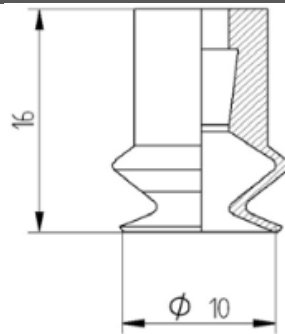

Faltenbalgsauger aus Silikon
Temperaturbeständig bis 200°C

Balghub: 3 mm

Anschlusselement:

- H004932
- H004933

Federelement:

- H004976

Faltenbalgsauger Vinyl Ø 13 mm - Art.Nr. C003030

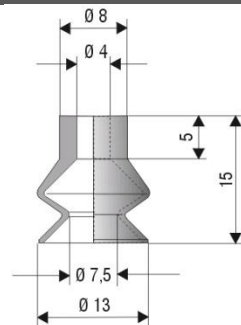
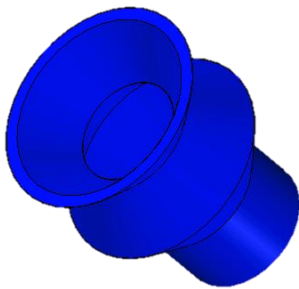

Faltenbalgsauger aus Vinyl
Temperaturbeständigkeit bis 85°C

Balghub: 5 mm

Faltenbalgsauger SI Ø 15 mm - Art.-Nr. H004904

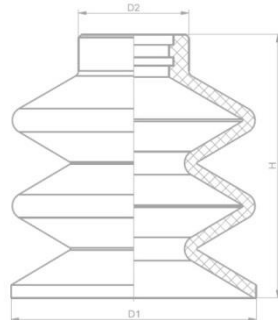

Faltenbalgsauger aus Silikon
Temperaturbeständig bis 200°C

Bemerkung: Balghub 4.5 mm



Faltenbalgsauger SI Ø 15.5 mm - Art.-Nr. H004903

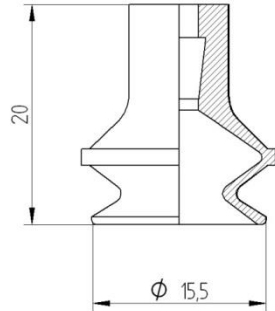
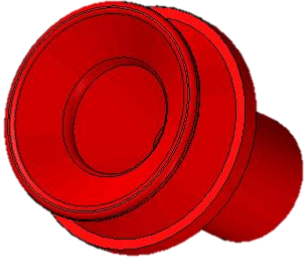

Faltenbalgsauger aus Silikon
Temperaturbeständig bis 200°C

Bemerkung : Balghub 4 mm

Anschlusselement:
- H004932

Federelement:
- H004976

Faltenbalgsauger PU Ø 30 mm - Art.-Nr. H004916

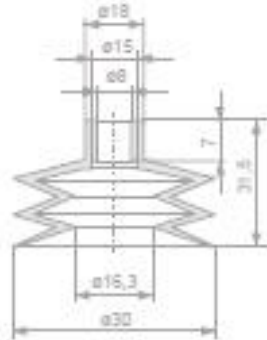

Faltenbalgsauger aus Polyurethan
gelb/braun
Temperaturbeständig bis 80°C

Balghub 12 mm

Anschlusselement:
- H004937

Faltenbalgsauger PU Ø 48 mm - Art.-Nr. H004917

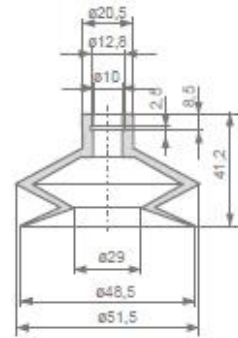

Faltenbalgsauger aus Polyurethan
gelb/braun

Temperaturbeständig bis 80°C

Balghub: 8 mm
Anschlusselement:
- H004938



Ovalsauger

Ovalsauger NBR 18x6 - Art.-Nr. H004821

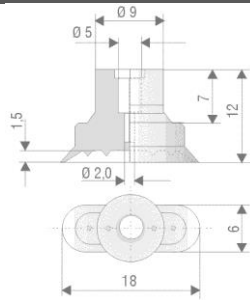

Ovalsauger aus Peruban
Temperaturbeständigkeit bis 90°C°

Balghub: 1 mm

Anschlusselement:
- C003084

Ovalsauger NBR 30x10 - Art.Nr. H004824

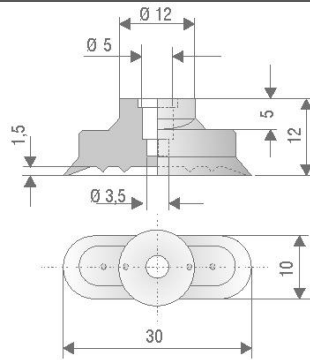

Ovalsauger aus Peruban
Temperaturbeständig bis 90°C

Balghub: 2 mm

Ovalsauger NBR 36x12 - Art.Nr. H004825

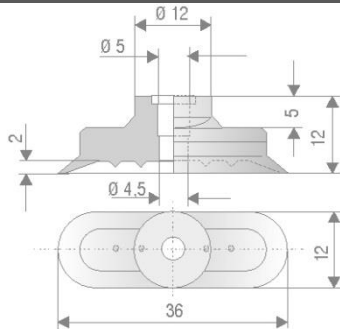

Ovalsauger aus Peruban
Temperaturbeständig bis 90°C

Balghub: 2 mm



Anschlusselemente

Anschlusselement Haftsauger - Art.-Nr. H004831

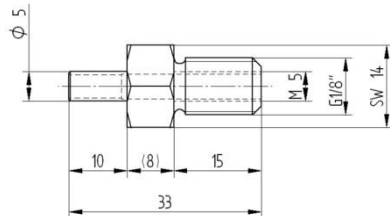
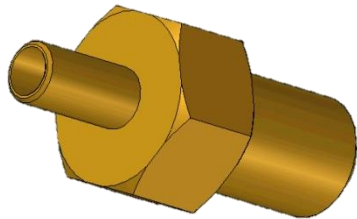

Anschlusselement aus Messing

Passende Sauger:

- H004801 (Flachsauger ϕ 4mm)
- H004802 (Flachsauger ϕ 6.3mm)

Bemerkung : Flachsauger muss eingeklebt werden

Anschlusselement Haftsauger - Art.-Nr. H004832

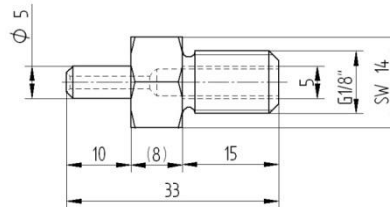
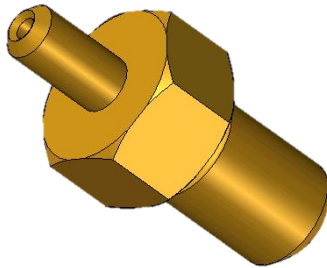

Anschlusselement aus Messing

Passende Sauger:

- H004804 (Flachsauger ϕ 16mm)

Bemerkung : Flachsauger muss eingeklebt werden

Anschlusselement Haftsauger - Art.-Nr. H004833

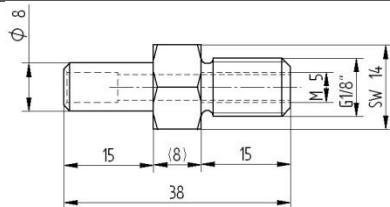
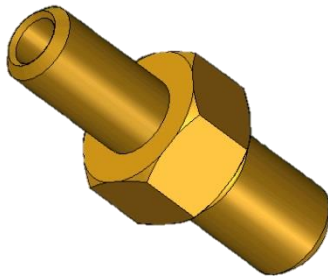

Anschlusselement aus Messing

Passende Sauger:

- H004803 (Flachsauger ϕ 10mm)
- H004805 (Flachsauger ϕ 25mm)

Bemerkung : Flachsauger muss eingeklebt werden

Anschlusselement Faltenbalgsauger - Art.-Nr. H004932

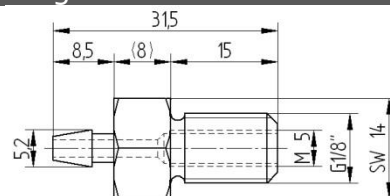
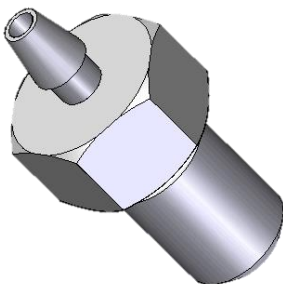

Anschlusselement aus Aluminium

Passende Sauger:

- H004902 (Balgsauger ϕ 10mm)
- H004903 (Balgsauger ϕ 15.5mm)

Bemerkung : Balgsauger wird nur aufgesteckt



Anschlusselement Faltenbalgsauger - Art.-Nr. H004931

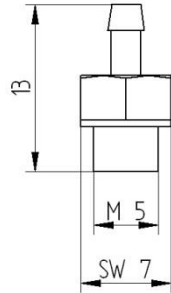
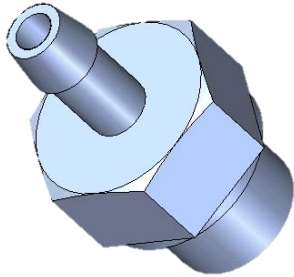

Anschlusselement aus Messing

Passende Sauger:
- H004901 (Balgsauger Ø 6mm)

Bemerkung : Balgsauger wird nur aufgesteckt

Anschlusselement Faltenbalgsauger - Art.-Nr. H004933

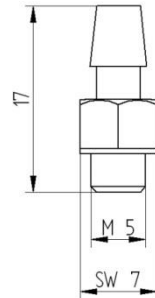
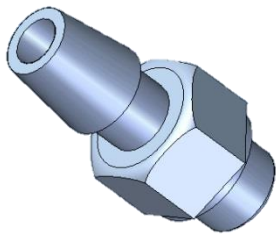

Anschlusselement aus Messing

Passende Sauger:
- H004902 (Balgsauger Ø 10mm)
- H004903 (Balgsauger Ø 15.5mm)

Bemerkung : Balgsauger wird nur aufgesteckt

Anschlusselement Faltenbalgsauger - Art.-Nr. H004937

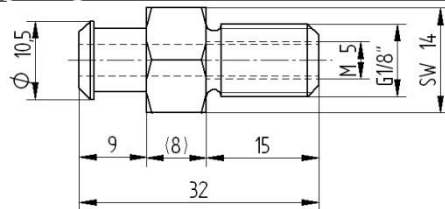
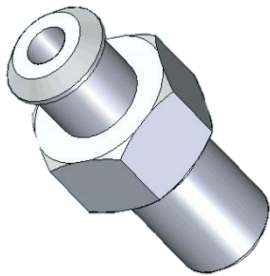

Anschlusselement aus Messing

Passende Sauger:
- H004916 (Balgsauger Ø 30mm)

Bemerkung : Balgsauger muss mit Schlauchklemme befestigt werden

Anschlusselement Faltenbalgsauger - Art.Nr. H004938

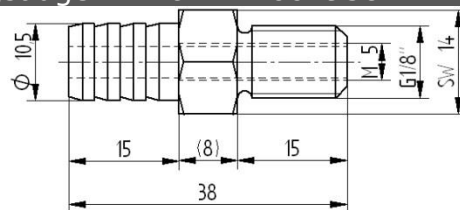
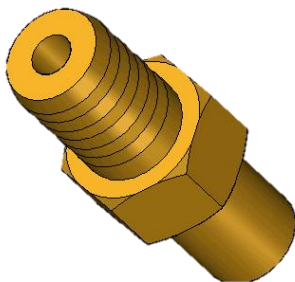

Anschlusselement aus Messing

Passende Sauger:
- H004917 (Balgsauger Ø 30mm)

Bemerkung: Balgsauger muss mit Schlauchklemmen befestigt werden



Anschlusselement M5-AG / SW8 - Art.-Nr. C003058

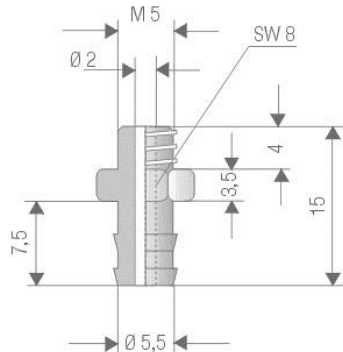
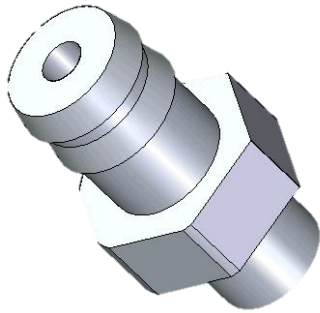

Anschlusselement aus Messing

Passende Sauger:

- C003021 (Balgsauger Ø 6.5mm)
- C003029 (Balgsauger Ø 6.5mm)

Bemerkung: Balgsauger wird nur aufgesetzt

Anschlusselement 1/8"-AG / SW14 - Art.-Nr. C003070

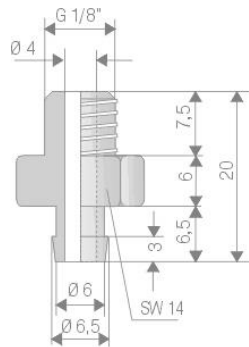
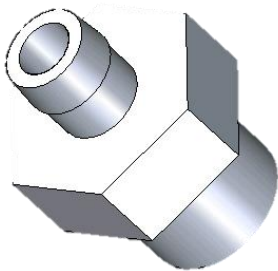

Anschlusselement aus Messing

Passende Sauger:

- C003021 (Balgsauger Ø 6.5mm)
- C003029 (Balgsauger Ø 6.5mm)

Bemerkung: Balgsauger wird nur aufgesetzt

Anschlusselement 1/8"-AG / SW14 - Art.-Nr. C003082

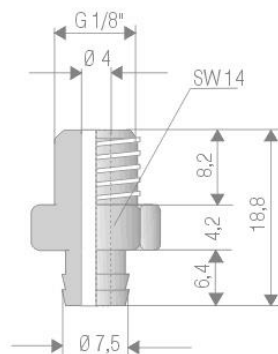
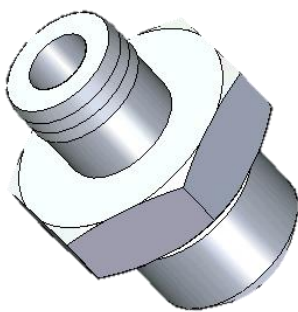

Anschlusselement aus Messing

Passende Sauger:

- C003022 (Balgsauger Ø10 mm)
- C003081 (Flachsauger Ø 30mm)

Bemerkung: Sauger wird nur aufgesetzt

Anschlusselement 1/8" -AG / SW14 - Art.-Nr. C003084

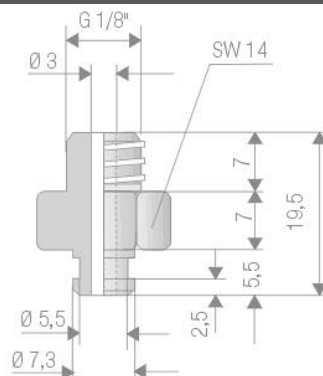
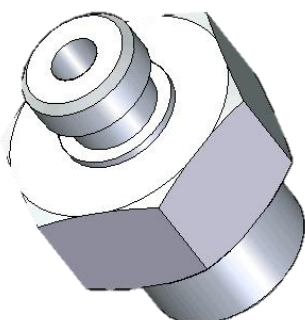

Anschlusselement aus Messing

Passende Sauger:

- H004821 (Ovalsauger 18x6)

Bemerkung: Ovalsauger wird nur aufgesetzt



Anschlusselement 1/8" -AG / SW19 - Art.-Nr. H004869

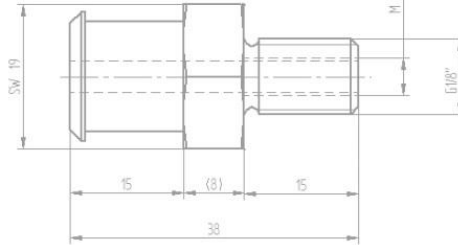
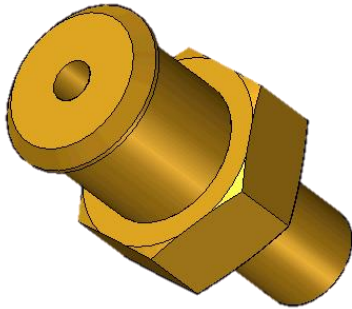

Anschlusselement aus Messing

Passende Sauger:
- H004865 (Flachsauger Ø 80mm)

Bemerkung: Sauger wird nur aufgesetzt

Anschlusselement M5 -AG / SW8 - Art.-Nr. H004835

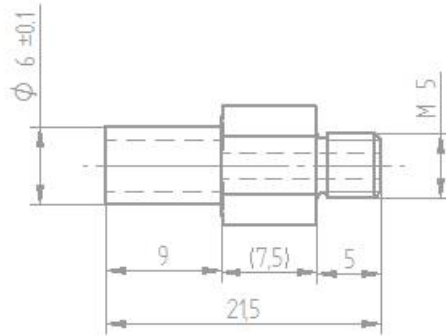
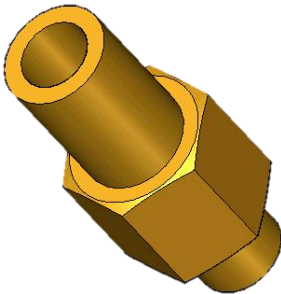

Anschlusselement aus Messing

Passende Sauger:
- H004801 (Flachsauger Ø 4mm)
- H004801 (Flachsauger Ø 6.3mm)

Bemerkung : Flachsauger muss eingeklebt werden



Federelemente

Federelement für Haftsauger Ø 4 / 6.3 mm - Art.-Nr. H004981

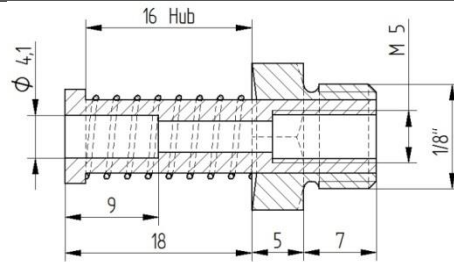
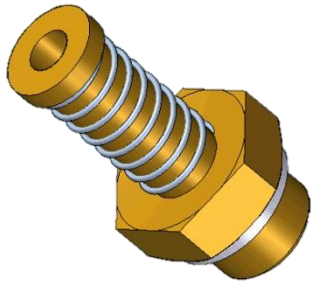

Federelement aus Messing
Federhub: 8 mm

Passende Sauger:

- H004801 (Flachsauger Ø 4mm)
- H004802 (Flachsauger Ø 6.3mm)

Bemerkung : Flachsauger muss eingeklebt werden

Federelement G1/8"/M5 - Art.-Nr. C003118

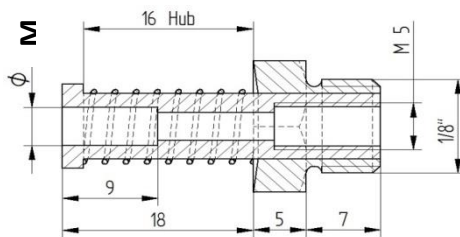
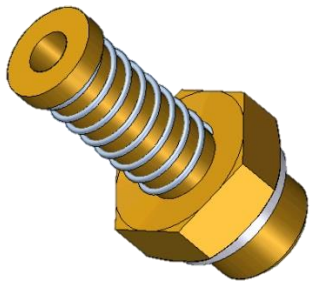

Federelement aus Messing
Federhub: 8 mm

Passende Sauger:

- H004801 (Flachsauger Ø 4mm)
- H004802 (Flachsauger Ø 6.3mm)

Bemerkung : Flachsauger muss eingeklebt werden

Federelement für Haftsauger Ø 10 mm - Art.-Nr. H004982

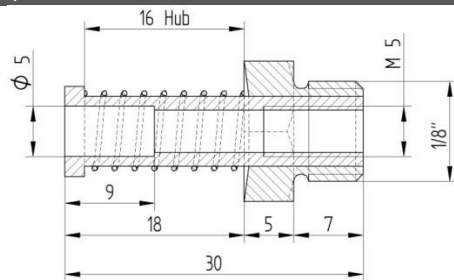
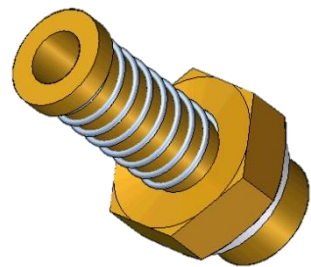

Federelement aus Messing
Federhub: 8 mm

Passende Sauger:

- H004803 (Flachsauger Ø 10mm)

Bemerkung : Flachsauger muss eingeklebt werden

Federelement für Faltenbalgsauger - Art.-Nr. H004976

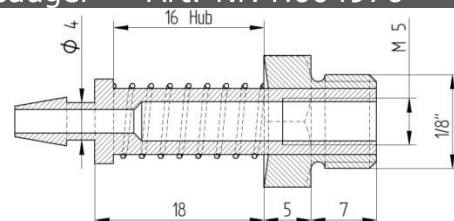
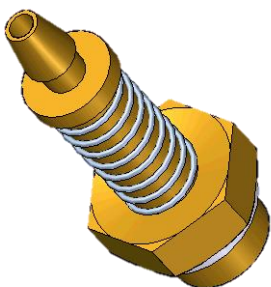

Federelement aus Messing
Federhub: 8 mm

Passende Sauger:

- H004902 (Balgsauger Ø 10mm)
- H004903 (Balgsauger Ø 15.5mm)

Bemerkung : Balgsauger wird nur aufgesteckt



Federelement M16 - Art.-Nr. H004983

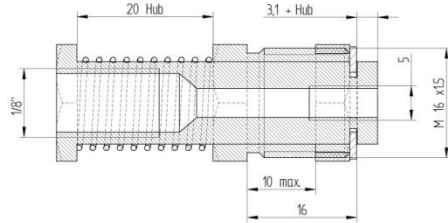
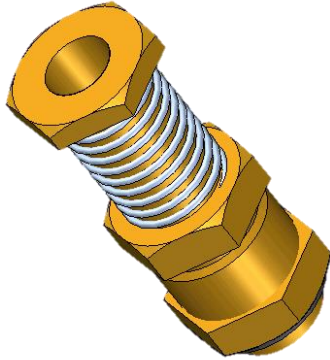

Federelement aus Messing
Federhub: 15 mm

Anwendungsbereich :
In Kombination mit allen 1/8" Gewinden

Federelement - Art.-Nr. C003072

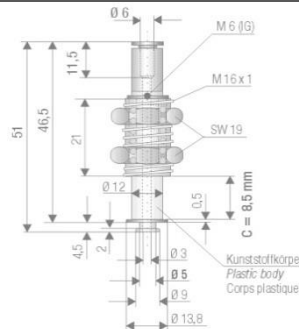
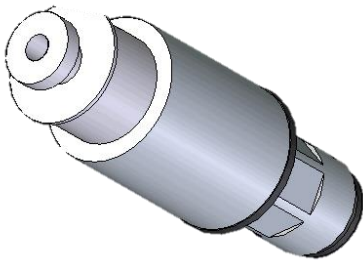

Federelement aus Kunststoff
Federhub: 8.5 mm

Anschluss: Schlauch Ø6 aussen

Passende Sauger:
- C003071 (Flachsauger Ø 15mm)

Bemerkung: Sauger wird nur aufgesetzt

Federelement M3 - Art.-Nr. C003091

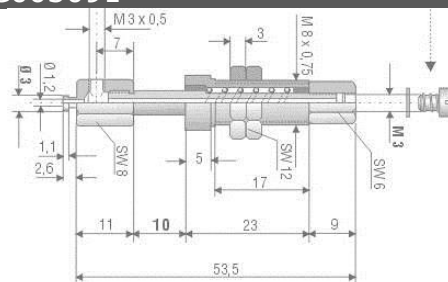
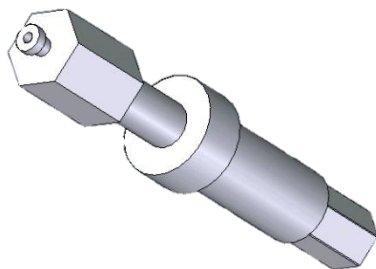

Federelement aus Messing
Federhub: 10 mm

Anschluss seitlich oder hinten M3

Passender Sauger:
- C003089 (Flachsauger Ø 3.5mm)

Bemerkung: Sauger wird nur aufgesetzt

Federelement M5 - Art.-Nr. C003092

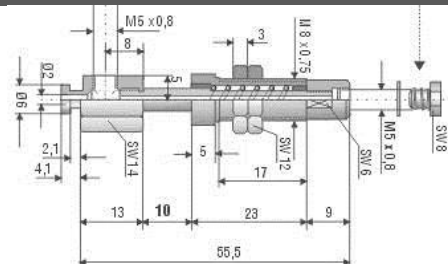
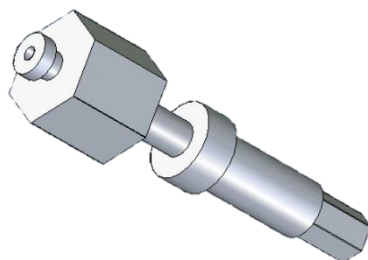

Federelement aus Messing
Federhub 10 mm

Anschluss seitlich oder hinten M5

Passender Sauger:
- C003090 (Flachsauger Ø 6mm)

Bemerkung: Flachsauger wird nur aufgesetzt



Baugruppen

Federelement mit Haftsauger SI Ø 6 mm - Art.-Nr. H004838

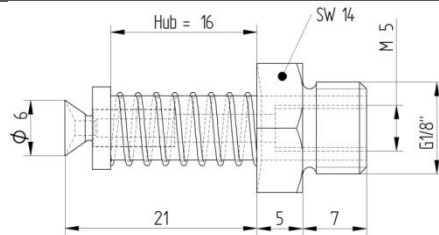
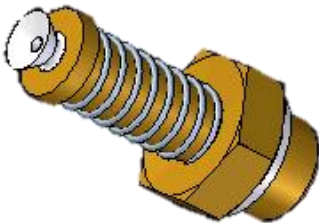

Federelement aus Messing mit
Flachsauger Si Ø 6 mm
Anschlussgewinde:
- G1/8\" aussen
- M5 innen

Baugruppe : Komplett montiert

Bemerkung : Federhub 8 mm

Federelement mit Haftsauger SI Ø 10 mm - Art.-Nr. H004839

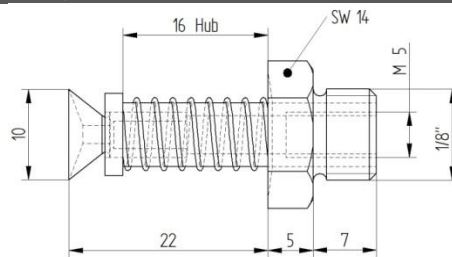
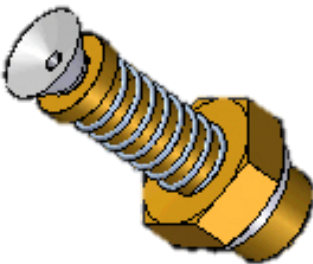

Federelement aus Messing mit
Flachsauger Si Ø 10 mm
Anschlussgewinde:
- G1/8\" aussen
- M5 innen

Baugruppe : Komplett montiert

Bemerkung : Federhub 8 mm

Haftsauger SI Ø 4 mm / M5 komplett - Art.-Nr. H004849

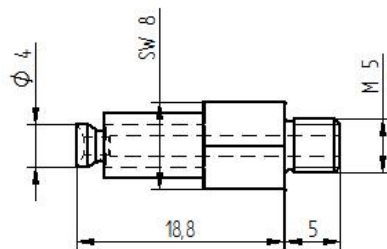
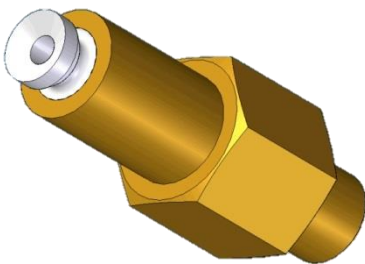

Anschlusselement aus Messing mit
Flachsauger SI Ø 4mm

Baugruppe komplett montiert

Haftsauger SI Ø 6.3 mm / M5 komplett - Art.-Nr. H004850

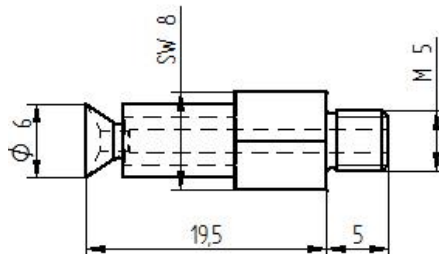
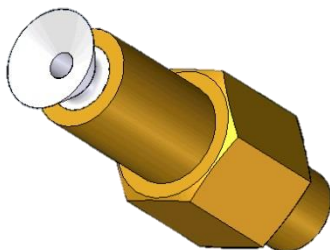

Anschlusselement aus Messing mit
Flachsauger SI Ø 6.3mm

Baugruppe komplett montiert



Haftsauger SI Ø 4 mm / G1/8"komplett - Art.-Nr. H004841

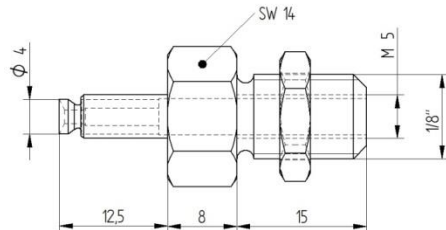
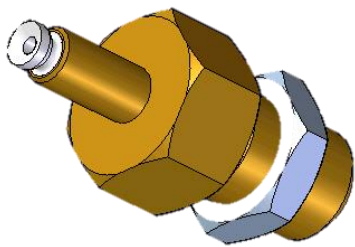

Anschlusselement aus Messing mit
Flachsauger Si Ø 4 mm
Anschlussgewinde:
- G1/8" aussen
- M5 innen

Baugruppe : Komplett montiert

Haftsauger SI Ø 6 mm / G1/8" komplett - Art.-Nr. H004842

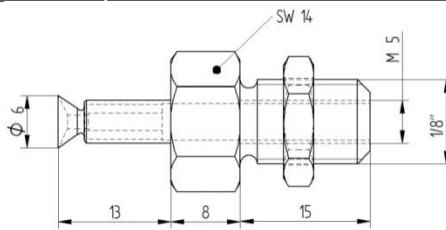
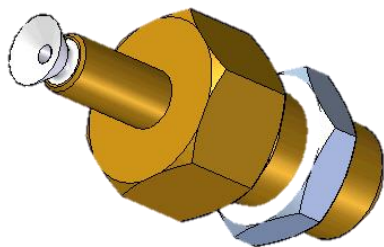

Anschlusselement aus Messing mit
Flachsauger Si Ø 6.3 mm
Anschlussgewinde:
- G1/8" aussen
- M5 innen

Baugruppe : Komplett montiert

Haftsauger SI Ø 10 mm / G1/8" komplett - Art.-Nr. H004843

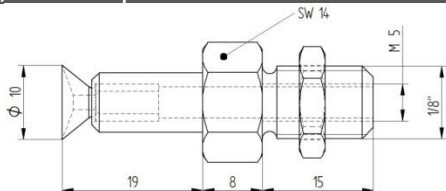
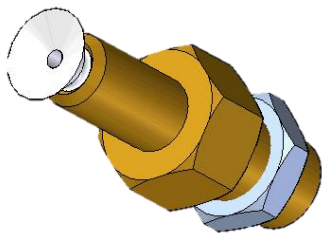

Anschlusselement aus Messing mit
Flachsauger Si Ø 10 mm
Anschlussgewinde:
- G1/8" aussen
- M5 innen

Baugruppe : Komplett montiert

Haftsauger SI Ø 16 mm / G1/8" komplett - Art.-Nr. H004844

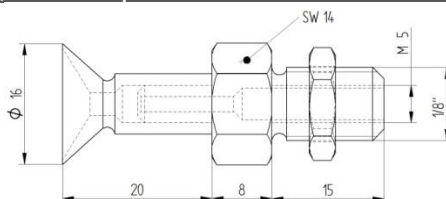
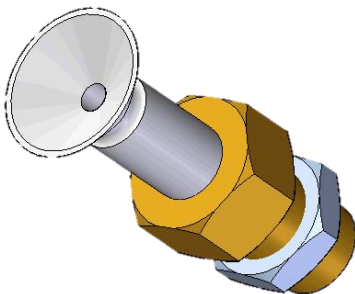

Anschlusselement aus Messing mit
Flachsauger Si Ø 16 mm
Anschlussgewinde:
- G1/8" aussen
- M5 innen

Baugruppe : Komplett montiert



Haftsauger SI Ø 25 mm / G1/8" komplett - Art.-Nr. H004845

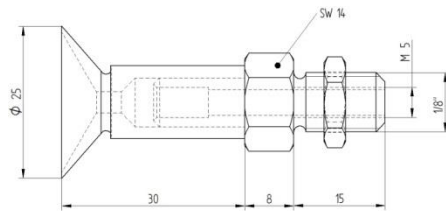
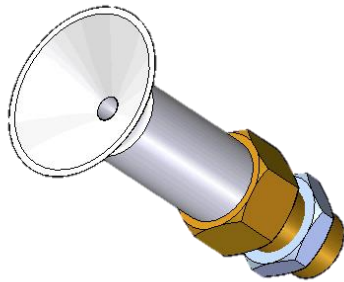

Anschlusselement aus Messing mit
Flachsauger Si Ø 25 mm
Anschlussgewinde:
- G1/8" aussen
- M5 innen

Baugruppe : Komplett montiert

Faltenbalgsauger SI Ø 6.5 mm / M5 komplett - Art.-Nr. C003059

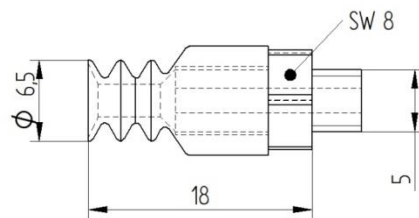

Anschlusselement aus Messing mit
Faltenbalgsauger Si Ø 6.5 mm
Anschlussgewinde M5

Baugruppe : Komplett montiert

Faltenbalgsauger SI Ø 6 mm / M5 komplett - Art.-Nr. C003095

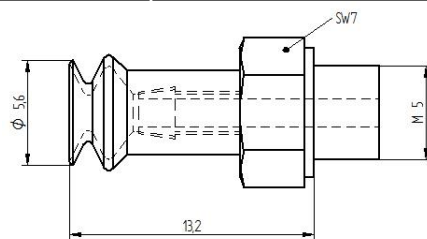
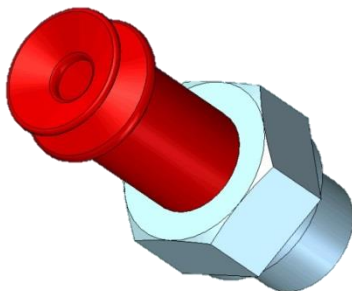

Anschlusselement aus Messing mit
Faltenbalgsauger SI Ø 6 mm
Anschlussgewinde M

Faltenbalgsauger SI Ø 10 mm / M5 komplett - Art.Nr. C003060

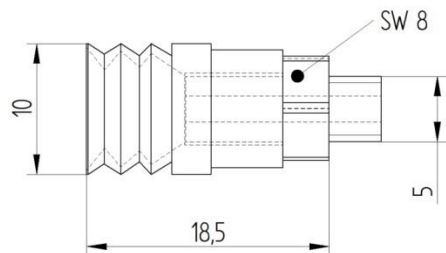

Anschlusselement aus Messing mit
Faltenbalgsauger Si Ø 10m
Anschlussgewinde M5

Baugruppe komplett montiert

Faltenbalgsauger SI Ø 10 mm / M5 komplett - Art.-Nr. C003096

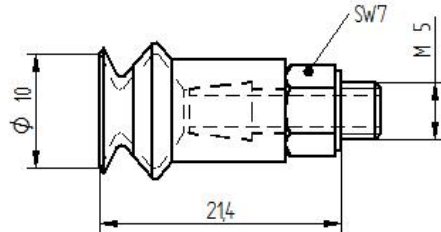
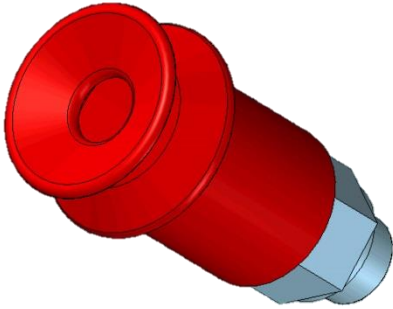

Anschlusselement aus Messing mit Faltenbalgsauger Si Ø 10mm
Anschlussgewinde M5

Baugruppe komplett montiert

Faltenbalgsauger SI Ø 10 mm / G1/8" komplett - Art.-Nr. H004942

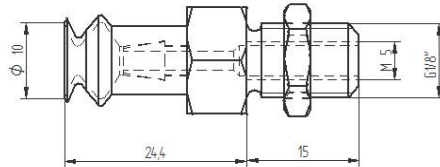
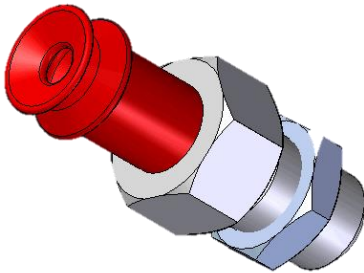

Anschlusselement aus Messing mit Faltenbalgsauger Si Ø 11 mm
Anschlussgewinde:

- G1/8" aussen
- M5 innen

Baugruppe : Komplett montiert

Faltenbalgsauger SI Ø 15 mm / M5 komplett - Art.-Nr. C003097

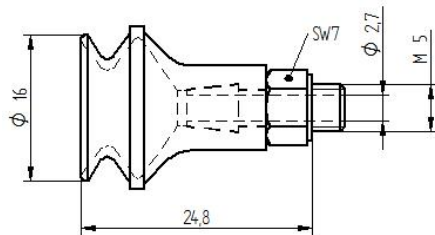

Anschlusselement aus Messing mit Faltenbalgsauger Si Ø 16 mm
Anschlussgewinde M5

Baugruppe : Komplett montiert

Faltenbalgsauger SI Ø 15 mm / G1/8" komplett - Art.-Nr. H004943

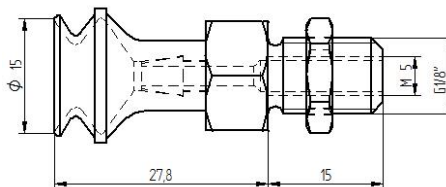
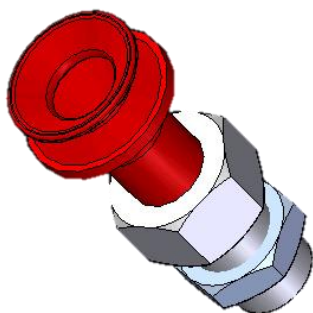

Anschlusselement aus Messing mit Faltenbalgsauger Si Ø 15.5 mm
Anschlussgewinde:

- G1/8" aussen
- M5 innen

Baugruppe : Komplett montiert



Faltenbalgsauger SI Ø 22 mm / G1/8" komplett - Art.-Nr. H004944

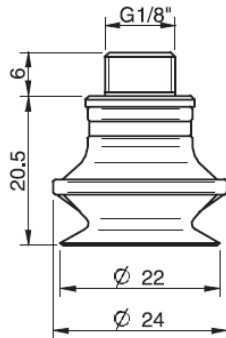
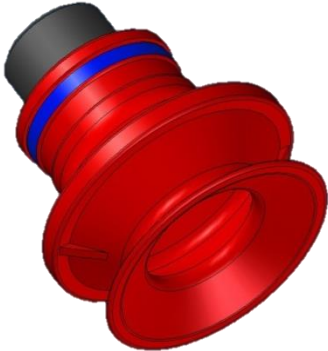

Faltenbalgsauger aus Silikon rot

Temperaturbeständig bis 200°C

Balghub: 7 mm

Anschlussaussengewinde:

- G1/8" aussen
- M5 innen

Faltenbalgsauger SI Ø 34 mm / G1/8"komplett - Art.-Nr. H004946

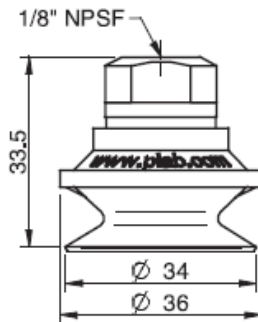
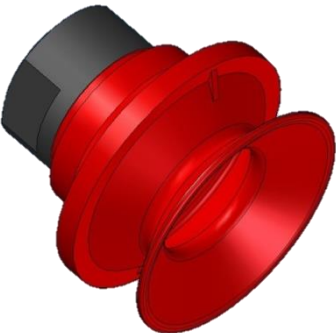

Faltenbalgsauger aus Silikon rot

Temperaturbeständig bis 200°C

Balghub: 12 mm

Anschlussinnengewinde:

- G1/8" innen

Faltenbalgsauger SI Ø 43 mm / G1/8" komplett - Art.-Nr. H004945

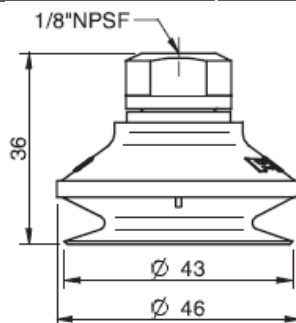
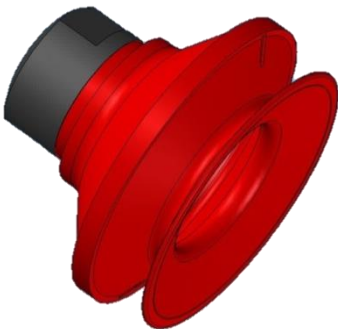

Faltenbalgsauger aus Silikon rot

Temperaturbeständig bis 200°C

Balghub: 8mm

Anschlussinnengewinde:

- G1/8" innen

Faltenbalgsauger PU Ø 30 mm / G1/8" komplett - Art.-Nr. H004956



Länge: 56 mm
 Aussengewinde: 1/8"
 Innengewinde: M5
 Schlüsselweite: 14 mm

Anschlusselement aus Aluminium mit
 Faltenbalgsauger PU Ø 30 mm
 abgeklemt

Anschlussgewinde:

- G1/8" aussen
- M5 innen

Baugruppe : Komplett montiert



Faltenbalgsauger PU Ø 48 mm / G1/8" komplett - Art.-Nr. H004957



Länge: 67 mm
 Aussengewinde: 1/8"
 Innengewinde: M5
 Schlüsselweite: 14 mm

Anschlusselement aus Aluminium mit
 Faltenbalgsauger PU Ø 48 mm
 angeklemt
 Anschlussgewinde:
 - G1/8" aussen
 - M5 innen

Baugruppe : Komplett montiert

Vakuumsauger SI Ø 30 mm / G1/8" komplett - Art.-Nr. H004862

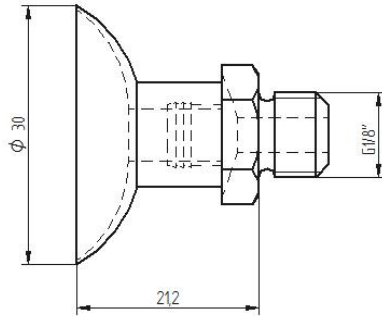
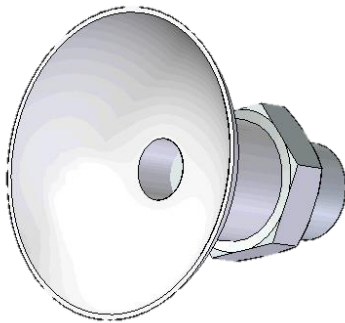

Vakuumsauger aus Silikon

Temperaturbeständig bis 200°C

Anschlussgewinde:
 - G1/8" aussen
 - M5 innen

Vakuumsauger SI Ø 50 mm / G1/8" komplett - Art.-Nr. H004863

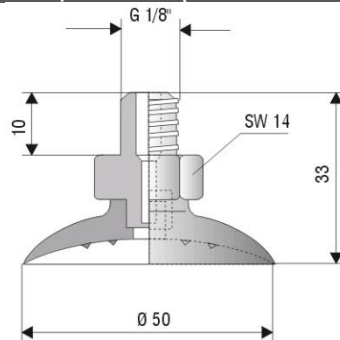

Vakuumsauger aus Silikon

Temperaturbeständig bis 200°C

Anschlussgewinde:
 - G1/8" aussen



Zangen

ZangeK ohne Überwachung - Art.Nr. H008412

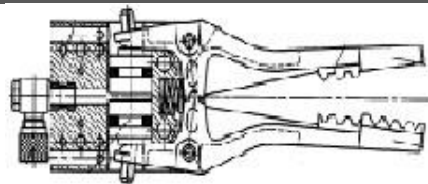

Zange aus Kunststoff schwarz

Gewicht zirka 60 Gramm

Bemerkung : Leichte und kostengünstige Zange zur Angussentnahme

ZangeF einfach gerade - Art.Nr. H006201

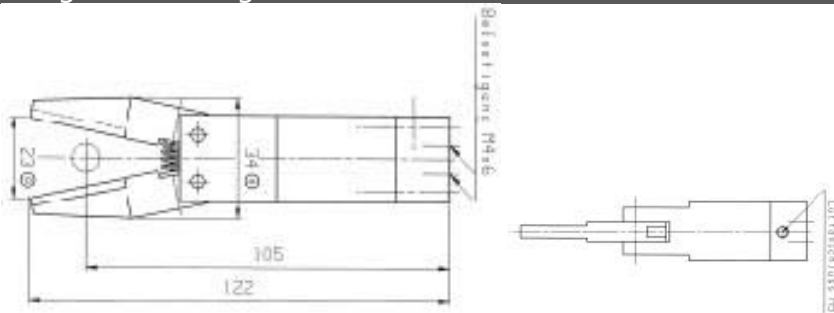

Zange aus Aluminium farblos eloxiert und Backen aus Stahl brüniert

Gewicht zirka 170 Gramm

Bemerkung : Robuste Standardzange zur Angussentnahme

ZangeF einfach gerade lang - Art.Nr. H006211



Zange aus Aluminium farblos eloxiert und Backen aus Stahl brüniert

Gewicht zirka 250 Gramm

Bemerkung : Robuste Zange mit H0erlängerung zur Angussentnahme

ZangeF gezahnt gerade - Art.Nr. H008481

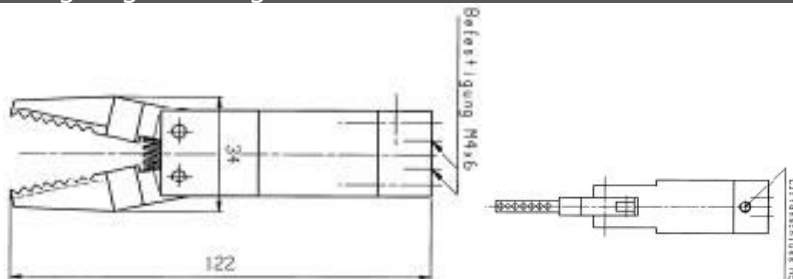

Zange aus Aluminium farblos eloxiert und Backen aus Stahl brüniert

Gewicht zirka 170 Gramm

Bemerkung : Robuste Zange mit gezahntem Backenpaar zur Angussentnahme



ZangeF einfach abgewinkelt 45° - Art.Nr H265010

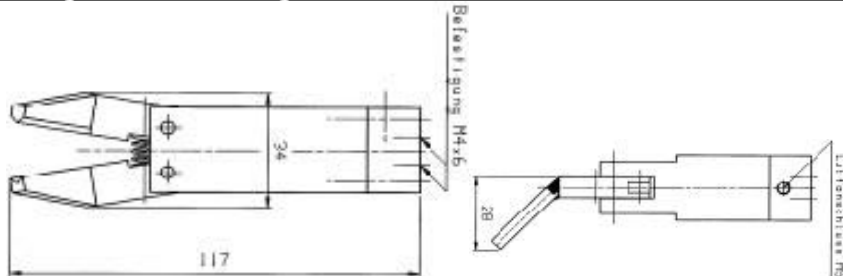

Zange aus Aluminium farblos eloxiert und Backen aus Stahl brüniert

Gewicht zirka 170 Gramm

Bemerkung : Robuste Zange mit abgewinkeltem Backenpaar zur Angussentnahme

ZangeF einfach abgewinkelt 78° - Art.Nr H008461

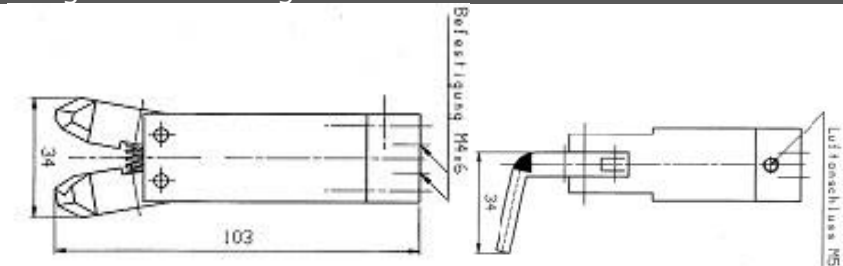

Zange aus Aluminium farblos eloxiert und Backen aus Stahl brüniert

Gewicht zirka 170 Gramm

Bemerkung : Robuste Zange mit abgewinkeltem Backenpaar zur Angussentnahme

ZangeF spezial abgewinkelt 78° - Art.Nr. H013964

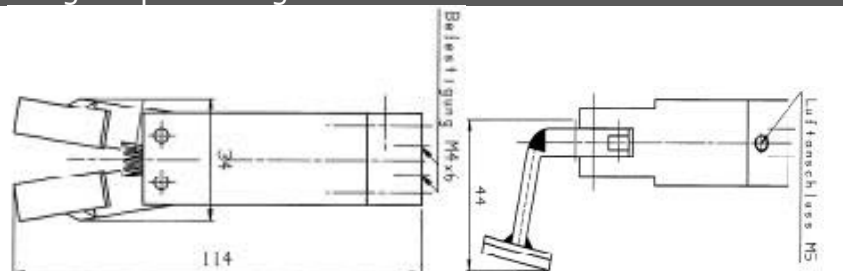

Zange aus Aluminium farblos eloxiert und Backen aus Stahl brüniert

Gewicht zirka 190 Gramm

Bemerkung : Robuste Zange mit abgewinkeltem Backenpaar mit Quersteg zur Angussentnahme

ZangeF zweifach gerade - Art.Nr. H006213

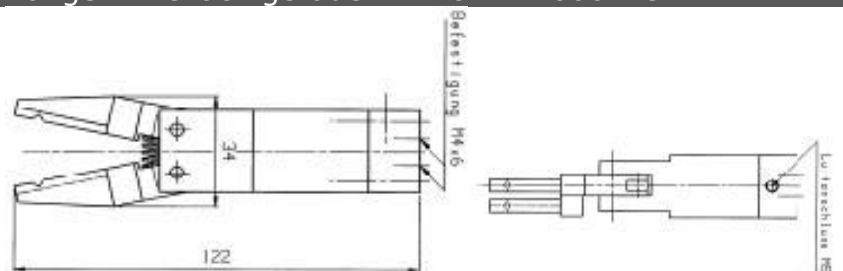

Zange aus Aluminium farblos eloxiert und Backen aus Stahl brüniert

Gewicht zirka 200 Gramm

Bemerkung : Robuste Zange mit zweifachem Backenpaar zur Angussentnahme

ZangeF dreifach gerade - Art.Nr. H006214

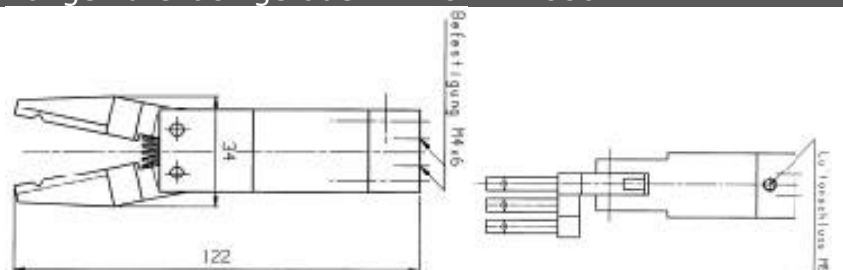

Zange aus Aluminium farblos eloxiert und Backen aus Stahl brüniert

Gewicht zirka 230 Gramm

Bemerkung : Robuste Zange mit dreifachem Backenpaar zur Angussentnahme

Überwachungskit zu ZangeF - Art.Nr. H006231

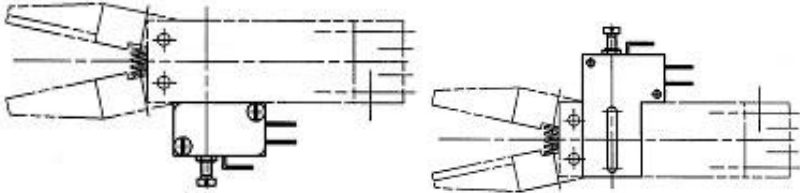

Überwachungskit bestehend aus:
 Mikroschalter
 Adapterplatte mit Feinjustierung
 Anschlusskabel mit Halterungen

Gewicht zirka 40 Gramm

Bemerkung : Anwesenheitskontrolle für die ZangeF

Deckel lang zu ZangeF - Art.Nr. H006212

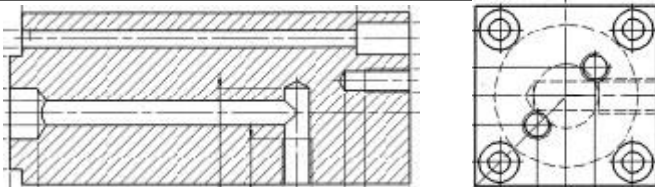

Deckel aus Aluminium farblos eloxiert

Gewicht zirka 80 Gramm

Bemerkung : Zum H0erlängerung der ZangeF um 50 mm

Zangenverlängerung 25 mm zu ZangeF - Art.Nr. H006224

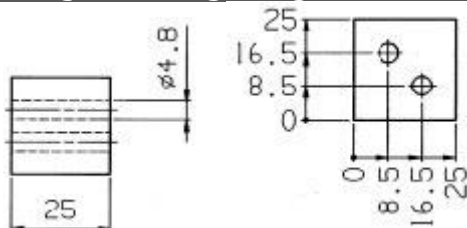

Zangenverlängerung aus Aluminium farblos eloxiert

Gewicht zirka 40 Gramm

Bemerkung : Zum Verlängern der ZangeF um 25 mm

ZangenH0erlängerung 50 mm zu ZangeF - Art.Nr. H006225

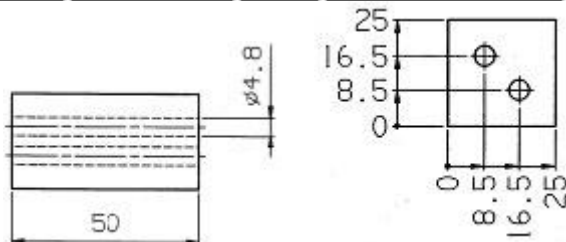

Zangenverlängerung aus Aluminium farblos eloxiert

Gewicht zirka 80 Gramm

Bemerkung : Zum Verlängern der ZangeF um 50 mm